

Single P-channel MOSFET

ELM13415CA-S

■ General description

ELM13415CA-S uses advanced trench technology to provide excellent $R_{ds(on)}$, low gate charge and low gate resistance. Internal ESD protection is included.

■ Features

- $V_{ds} = -20V$
- $I_d = -4A$ ($V_{gs} = -4.5V$)
- $R_{ds(on)} < 43m\Omega$ ($V_{gs} = -4.5V$)
- $R_{ds(on)} < 54m\Omega$ ($V_{gs} = -2.5V$)
- $R_{ds(on)} < 73m\Omega$ ($V_{gs} = -1.8V$)
- ESD protected

■ Maximum absolute ratings

Parameter	Symbol	Limit	Unit	Note	
Drain-source voltage	V_{ds}	-20	V		
Gate-source voltage	V_{gs}	± 8	V		
Continuous drain current	I_d	$T_a = 25^\circ C$	-4.0	A	
		$T_a = 70^\circ C$	-3.5		
Pulsed drain current	I_{dm}	-30	A	3	
Power dissipation	P_d	$T_a = 25^\circ C$	1.5	W	2
		$T_a = 70^\circ C$	1.0		
Junction and storage temperature range	T_j, T_{stg}	-55 to 150	$^\circ C$		

■ Thermal characteristics

Parameter		Symbol	Typ.	Max.	Unit	Note
Maximum junction-to-ambient	$t \leq 10s$	$R_{\theta ja}$	65	80	$^\circ C/W$	1
Maximum junction-to-ambient	Steady-state		85	100	$^\circ C/W$	1, 4
Maximum junction-to-lead	Steady-state	$R_{\theta jl}$	43	52	$^\circ C/W$	

■ Pin configuration

SOT-23(TOP VIEW)

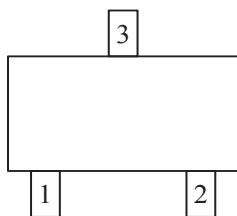

Pin No.	Pin name
1	GATE
2	SOURCE
3	DRAIN

■ Circuit

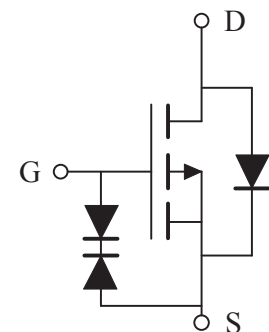

Single P-channel MOSFET

ELM13415CA-S

■ Electrical characteristics

Ta=25°C

Parameter	Symbol	Condition	Min.	Typ.	Max.	Unit
STATIC PARAMETERS						
Drain-source breakdown voltage	BV _{dss}	I _d =-250μA, V _{gs} =0V	-20			V
Zero gate voltage drain current	I _{dss}	V _{ds} =-20V			-1	μA
		V _{gs} =0V	T _j =55°C		-5	
Gate-body leakage current	I _{gss}	V _{ds} =0V, V _{gs} =±8V			±10	μA
Gate threshold voltage	V _{gs(th)}	V _{ds} =V _{gs} , I _d =-250μA	-0.30	-0.57	-0.90	V
On state drain current	I _{d(on)}	V _{gs} =-4.5V, V _{ds} =-5V	-30			A
Static drain-source on-resistance	R _{dson}	V _{gs} =-4.5V		37	43	mΩ
		I _d =-4A	T _j =125°C	52	62	
		V _{gs} =-2.5V, I _d =-4A		45	54	
		V _{gs} =-1.8V, I _d =-2A		54	73	
		V _{gs} =-1.5V, I _d =-1A		65		
Forward transconductance	G _{fs}	V _{ds} =-5V, I _d =-4A		20		S
Diode forward voltage	V _{sd}	I _s =-1A, V _{gs} =0V		-0.64	-1.00	V
Max. body-diode continuous current	I _s				-2	A
DYNAMIC PARAMETERS						
Input capacitance	C _{iss}		620	780	940	pF
Output capacitance	C _{oss}	V _{gs} =0V, V _{ds} =-10V, f=1MHz	80	115	150	pF
Reverse transfer capacitance	C _{rss}		50	80	110	pF
SWITCHING PARAMETERS						
Total gate charge	Q _g	V _{gs} =-4.5V, V _{ds} =-10V	7.4	9.3	11.0	nC
Gate-source charge	Q _{gs}	I _d =-4A	1.2	1.5	1.8	nC
Gate-drain charge	Q _{gd}		1.0	1.8	2.5	nC
Turn-on delay time	t _{d(on)}			120		ns
Turn-on rise time	t _r	V _{gs} =-4.5V, V _{ds} =-10V		240		ns
Turn-off delay time	t _{d(off)}	R _l =2.5Ω, R _{gen} =3Ω		2.8		ns
Turn-off fall time	t _f			2.0		ns
Body diode reverse recovery time	t _{rr}	I _f =-4A, dI/dt=500A/μs	11	14	17	ns
Body diode reverse recovery charge	Q _{rr}	I _f =-4A, dI/dt=500A/μs	24	30	36	nC

NOTE :

- The value of R_{θja} is measured with the device mounted on 1in2 FR-4 board of 2oz. Copper, in still air environment with Ta =25°C. The value in any given application depends on the user's specific board design.
- The power dissipation P_d is based on T_{j(Max)}=150°C, using 10s junction-to-ambient thermal resistance.
- Repetitive rating, pulse width limited by junction temperature T_{j(Max)}=150°C. Ratings are based on low frequency and duty cycles to keep initial T_j=25°C.
- The R_{θja} is the sum of the thermal impedance from junction to lead R_{θjl} and lead to ambient.
- The static characteristics in Figures 1 to 6 are obtained using <300μs pulses, duty cycle 0.5% max.
- These curves are based on the junction-to-ambient thermal impedance which is measured with the device mounted on 1in2 FR-4 board with 2oz.Copper, assuming a maximum junction temperature of T_{j(Max)}=150°C. The SOA curve provides a single pulse rating.

Single P-channel MOSFET

ELM13415CA-S

■ Typical electrical and thermal characteristics

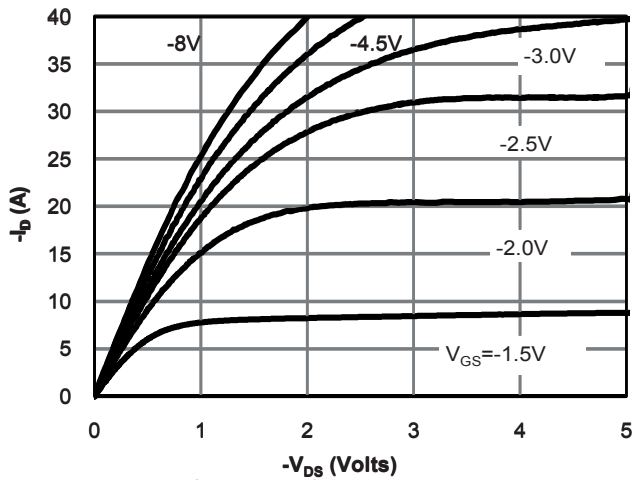

Fig 1: On-Region Characteristics (Note E)

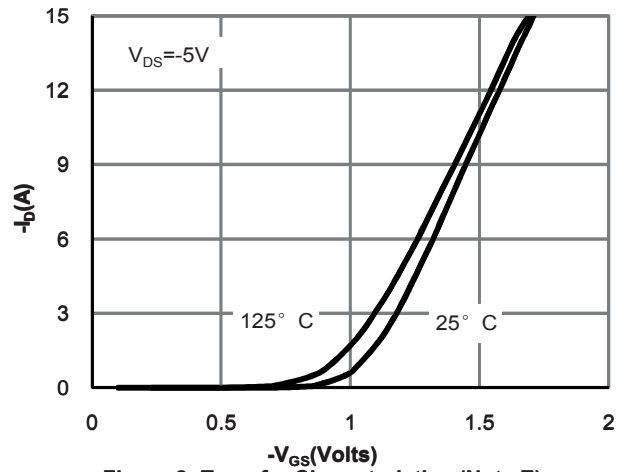

Figure 2: Transfer Characteristics (Note E)

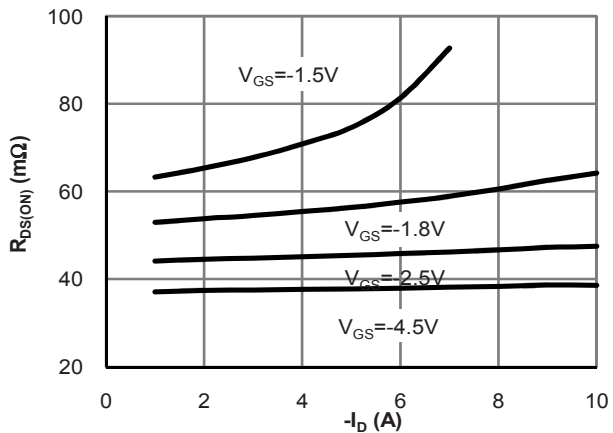

Figure 3: On-Resistance vs. Drain Current and Gate Voltage (Note E)

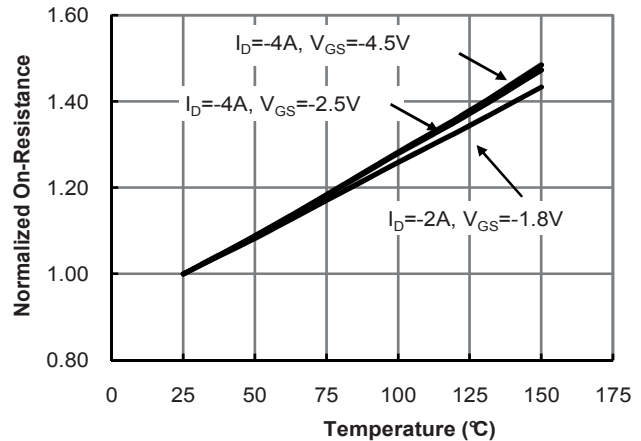

Figure 4: On-Resistance vs. Junction Temperature (Note E)

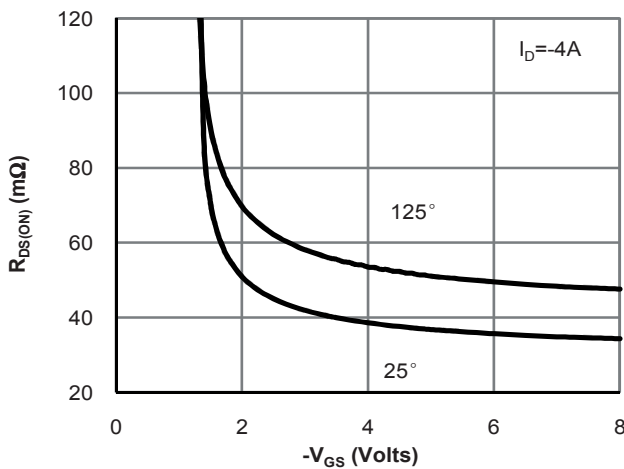

Figure 5: On-Resistance vs. Gate-Source Voltage (Note E)

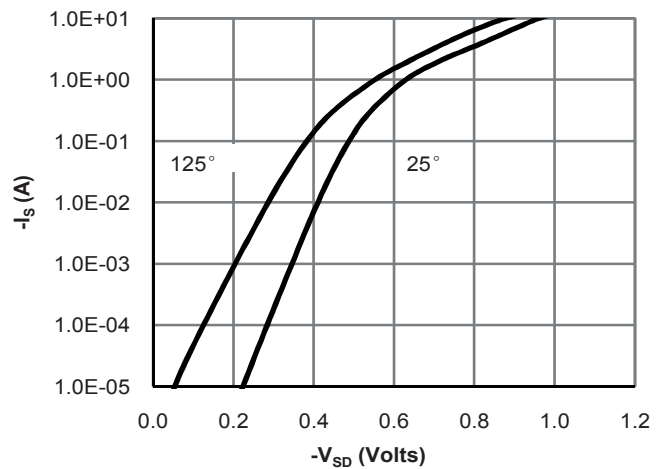

Figure 6: Body-Diode Characteristics (Note E)

Single P-channel MOSFET

ELM13415CA-S

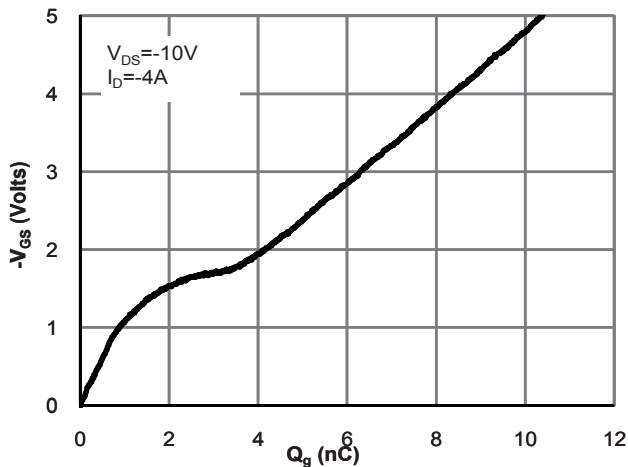

Figure 7: Gate-Charge Characteristics

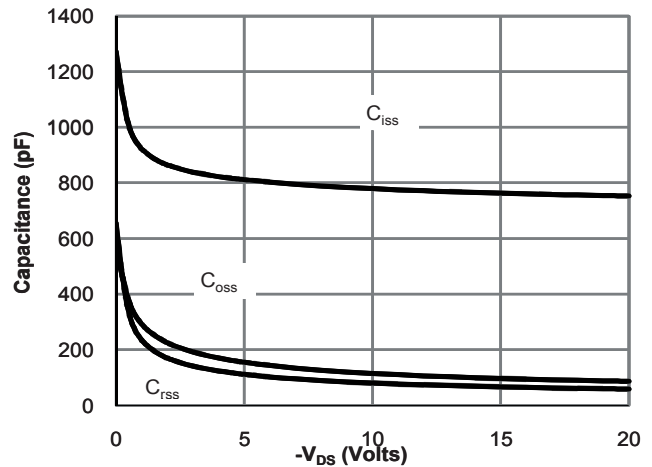

Figure 8: Capacitance Characteristics

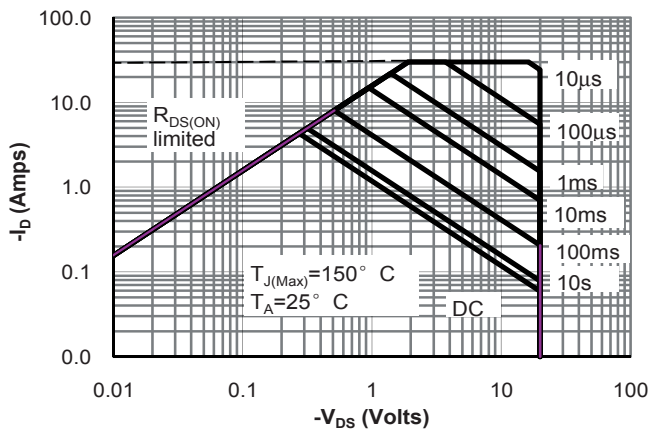

Figure 9: Maximum Forward Biased Safe Operating Area (Note F)

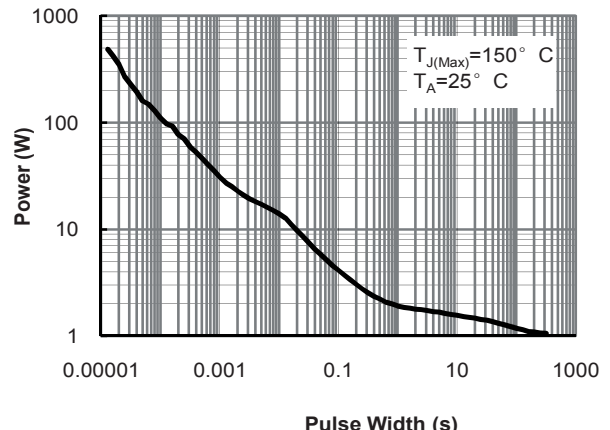

Figure 10: Single Pulse Power Rating Junction-to-Ambient (Note F)

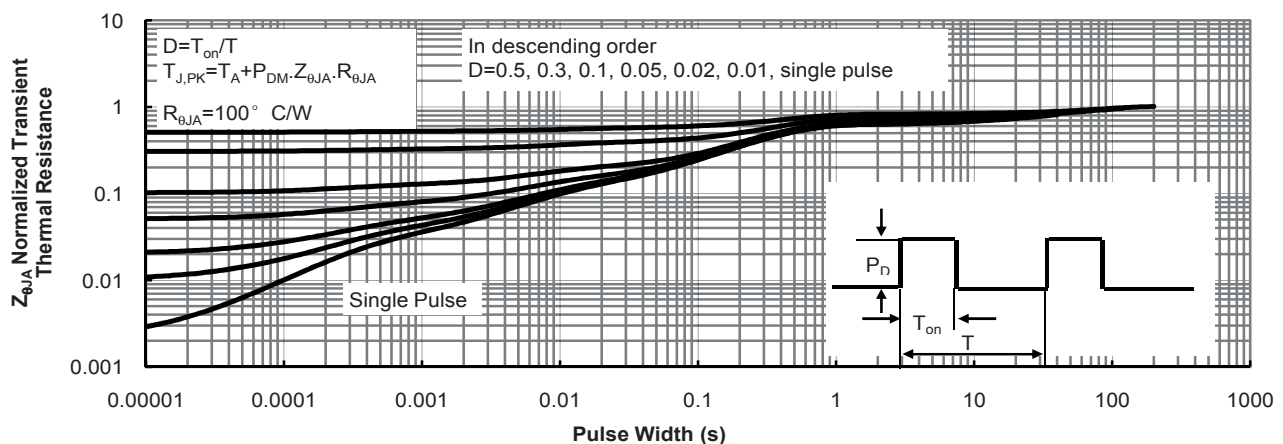

Figure 11: Normalized Maximum Transient Thermal Impedance (Note F)

Single P-channel MOSFET

ELM13415CA-S

■ Test circuit & waveform

Gate Charge Test Circuit & Waveform

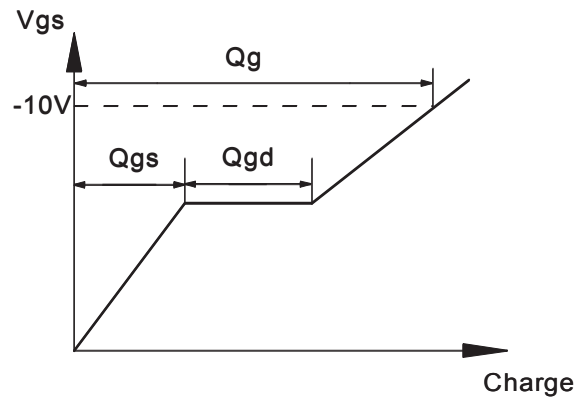
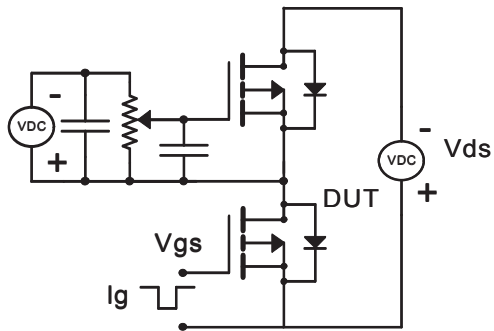

Resistive Switching Test Circuit & Waveforms

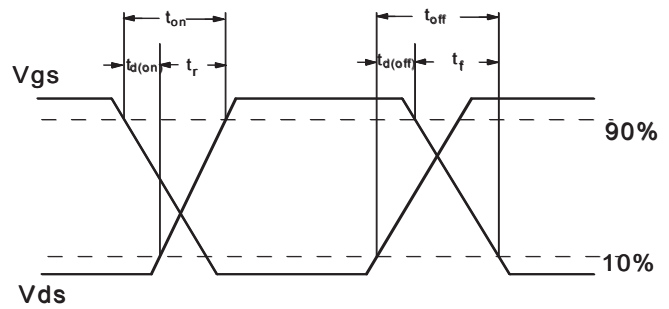
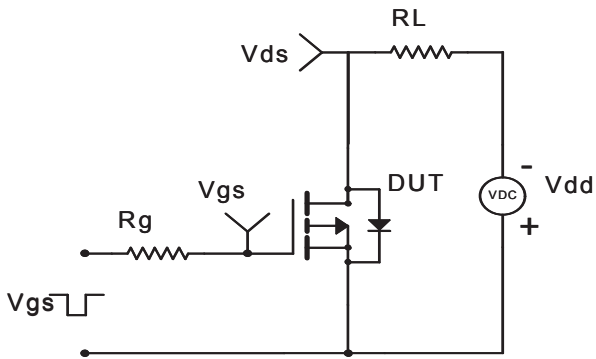

Diode Recovery Test Circuit & Waveforms

